

BCT-102E-M

The BCT-102E-M offers an ideal meal capacity of 125-300 meals.

USPH Approved & Built for Life at Sea - the BCT-102E-M is designed for the special needs of marine applications. Our strong door spring prevents the door from slamming or opening in rough seas. The flanged feet can be securely bolted to the deck.

Exceptional Design for Exceptional Kitchens - the Blodgett Combi is characterized by quality and simplicity. It has a unique ability to combine form and function; beauty and functionality effortlessly blends together. It enables you to reach perfection every time and with every meal.

Cook the way you want - the Blodgett Combi touchscreen control lets you choose which kind of chef you want to be. You can cook manually and easily fine-tune your settings. Use pre-programmed recipes to ensure consistent, results every time. Or use the SmartChef feature which automatically selects the optimum settings for an effortless cooking process.



CAPACITY

- ❑ Standard pan cassette with 3.35" (85mm) spacing holds eight full size sheet pans or sixteen 12" x 20" x 2-1/2" deep North American hotel pans
- ❑ Optional pan cassette with 2.56" (65mm) spacing holds ten full size sheet pans or twenty 12" x 20" x 2" deep Gastronorm pans

STANDARD FEATURES

- External detachable core temperature probe with multiple measuring points. User friendly location reduces strain on the probe
- 21-1/2" (546 mm) stainless steel stand with runners & bolt down flanged feet
- Bright halogen lights for superior visibility
- Built in external hand shower
- Removable cleaning chemical bottle shelf
- 8 wire shelves
- Left door hinge, field reversible with purchase of kit
- One year parts and labor global oven warranty
- Virtual start-up and warranty registration online

OPTIONS & ACCESSORIES

(AT ADDITIONAL CHARGE)

■ Banqueting Accessories

- Pan cassette with 2.56" (65mm) spacing
- Pan cassette with 3.35" (85mm) spacing
- Plate cassette with 2.56" (65mm) spacing holds 63 plates
- Plate cassette with 3.35" (85mm) spacing holds 51 plates
- Transport trolley, to move the cassette
- Insulated thermal blanket with vent
- Additional core probe
- Extra wire oven racks
- Right hinge door
- Backflow preventer
- Extra year warranty
- Start-up inspection service by factory authorized service agent

(AT NO ADDITIONAL CHARGE)

- Optional pan cassette w/ 2.56" (65mm) spacing & 10 wire shelves per section in lieu of standard cassette & shelves

OVEN OPERATION

- Built in steam generator produces pure, dry steam
- Easy to use touchscreen control stores up to 500 recipes with up to 15 steps each
- Multiple cooking modes include hot air, CombiSmart, retherm, steaming, low-temperature steaming, forced steaming, proofing, preheating
- CombiOptima automatically measures and controls the humidity level in the oven
- SmartChef automatic cooking provides presets for grilling, steaming, braising, browning and breaded products. Select your desired cooking result from rare to well done, and your surface appearance from light to dark.
- Manual or automatic cooling
- Automatic humidity pulsing
- Timed steam injection or instant steam on demand at any point in the cook cycle
- Rack timing for setting individual timers for each rack
- Advanced rack timing for managing multiple recipes of the same group simultaneously on separate racks, including managing recipes to finish cooking at the same time
- Reversible 9 speed fan for optimum baking and roasting results
- Programmable vent release allows for automatic venting if desired
- USB port for data and recipe transfer
- HACCP recording and documentation
- Automated CombiWash system features very low water and detergent consumption and no contact with chemicals. No proprietary chemicals required, see owner's manual for detergent guidelines.
- Automatic delimiting system

CONSTRUCTION

- 304 stainless steel exterior and interior
- Dual pane tempered viewing window with hinged inner glass for easy cleaning
- Stainless steel door spring to prevent door from swinging open during rough seas
- Reinforced fan baffle
- Marine compliant fasteners
- 2" (50mm) fixed drain in the bottom center of cavity
- Door mounted stainless steel drip tray reduces the risk of wet floors
- Separate water lines, for cooking and quench
- Automatic safety door stops in positions 110° and 180°
- Left hinge door is field convertible to the right side (with the purchase of conversion kit)
- Two step safety door latch. The first step stops the fan.



SHORT FORM SPECIFICATIONS: Provide Blodgett Combi model BCT-102E-M electric boiler based combination-oven/steamer. The BCT-102E-M has a pan cassette with 3.35" (85mm) spacing that holds eight full size sheet pans or sixteen 12" x 20" x 2-1/2" deep North American hotel pans. The optional pan cassette with 2.5" (65mm) spacing holds ten full size sheet pans or twenty 12" x 20" x 2" deep Gastronorm pans.

Unit has a 304 stainless steel exterior and interior. Oven doors have dual pane tempered viewing windows with hinged inner glass for easy cleaning. Stainless steel spring prevents doors from opening in rough seas. Includes reinforced fan baffle and marine compliant fasteners. Includes a built in external hand shower and separate water lines. Unit shall have bright halogen lights for superior visibility and an external detachable core temperature probe. Oven stand features flanged bolt down feet. Oven has two separate water lines for cooking and quench. You may choose to cook with pressureless steam, hot air, or combination of steam and hot air.

The touchscreen control stores 500 recipes with 15 stages each, in addition to pre-programmed recipes. Multiple modes include hot air, combi, retherming, steaming, low-temperature steaming, forced steaming, proofing, cooling, and preheating. CombiOptima automatically measures and controls the humidity level in the oven. The control allows for timed steam injection or instant steam on demand at any point in the cook cycle. Rack timing provides individual timers for each rack. Advanced rack timing allows for timing multiple recipes of the same group simultaneously on separate racks of the oven. Use SmartChef automatic cooking presets for grilling, steaming, braising, browning and breaded products. HACCP quality control, USB connectivity and automatic service diagnosis are included. Programmable vent release allows for automatic venting if desired. The reversible 9 speed fan provides optimum baking and roasting results. The automated combi wash system features very low water and detergent consumption and no contact with chemicals.

Includes one-year parts and labor warranty. Provide start-up inspection service by a factory authorized service agent. Provide options and accessories as indicated.

NOTE: The company reserves the right to make substitutions of components without prior notice.

POWER SUPPLY

VOLTAGE	KW	PHASE	AMPERAGE
208	27	3AC	75 amp
220-240	27	3AC	67.9 amp
480	27	3AC	33 amp
440	27	3AC	36 amp
400	27	3AC or 3NAC	39 amp
415	27	3NAC	38 amp

50/60 hz field convertible

This appliance uses a variable frequency drive, which can be known to product high frequency electrical noise. In some cases units must be hard wired. This avoids false positives on ground fault devices susceptible to errors from electrical noise. All installations must comply with local and national codes.

WATER SUPPLY

Good quality water feed is the responsibility of the owner. Water quality must be within the following general guidelines.

TDS: 40-125 ppm	pH: 7.0-8.5
Hardness: 35-180 ppm	Silica: <13 ppm
Chloramine: <0.2 ppm	Chlorine: <0.2 ppm
Chlorides: <25 ppm	

The best defense against poor water quality is a water treatment system designed to meet your water quality conditions. Blodgett offers optional water treatment systems.

Pressure

- 40 (min)-50 (max) PSI

Connections

- 2" drain connection - max. drain temperature 140°F (60°C)
- 3/4" garden hose and metric cold water connection included

DRAIN





The drain piping must consist of temperature resistant material, greater than 160°F, and be of adequate diameter not to cause flow restriction. Improper materials may deform and cause restrictions, thus affecting performance.

Appliance is to be installed with backflow protection in accordance with federal, state or local codes.



DIMENSIONS ARE IN INCHES (MM)

LEGEND

-  FILTERED WATER
-  UNFILTERED WATER
-  DRAIN
-  ELECTRICAL
-  VENT

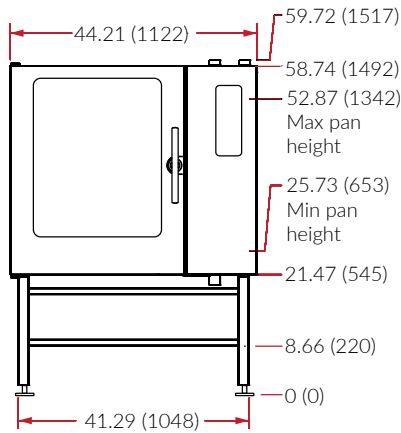

FRONT VIEW

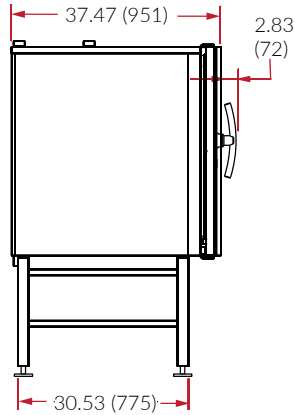

SIDE VIEW

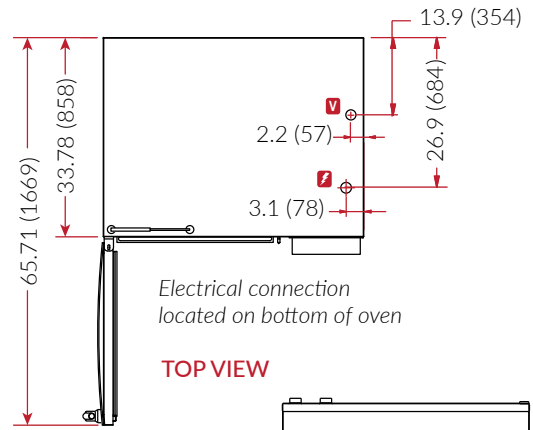

Electrical connection located on bottom of oven

TOP VIEW

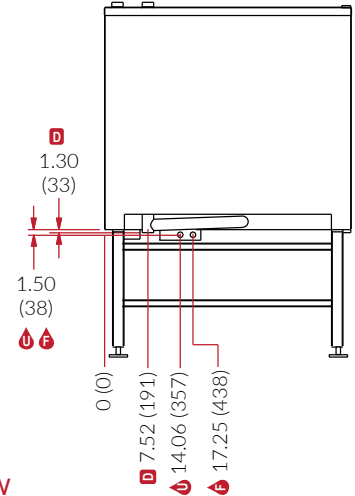

BACK VIEW

SHIPPING

CRATED WEIGHT

Oven	725 lbs (329 kg)
Stand	140 lbs (64 kg)

CRATE SIZE

Oven	40" H x 47" W x 48" D (1016 x 1194 x 1219 mm)
Stand	36" H x 42" W x 35" D (914 x 1067 x 889 mm)

DIMENSIONS & CLEARANCES

FLOOR SPACE

44.21" x 37.47" (1122 x 951mm)

UNIT HEIGHT

Oven on stand 59.72" (1517mm)

MINIMUM ENTRY CLEARANCES (per section)

Uncrated	37.47" (951mm)
Crated	40" (1016mm)

OVEN INSTALLATION CLEARANCE REQUIREMENTS

Kitchen Environment	Low temp.	High temp.*
Left Side & Back	2" (50mm)	2" (50mm)
Right (control) Side	2.8" (70mm)	16" (400mm)

* includes heat sources (fryers, hot plates, etc) placed on the control side of the combi

For servicing, Blodgett recommends maintaining at least 16" (400 mm) between the control side and walls or non moveable equipment.

